

# JB SANITARY

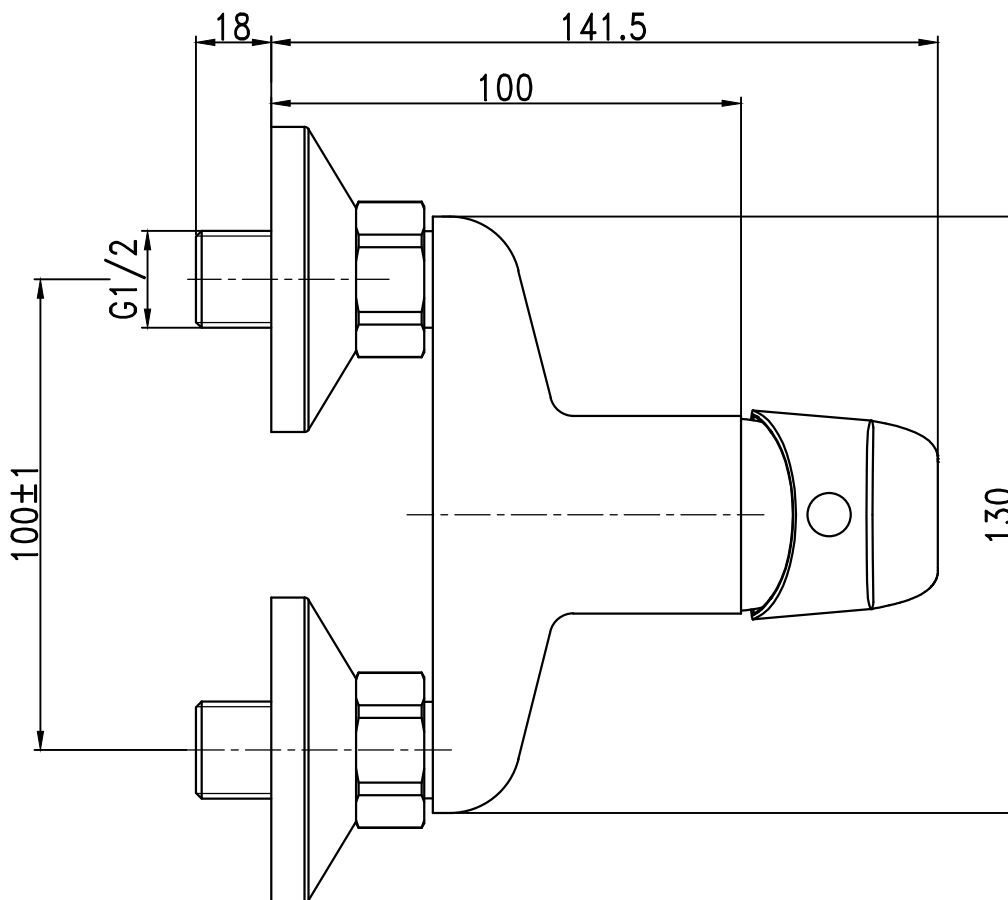
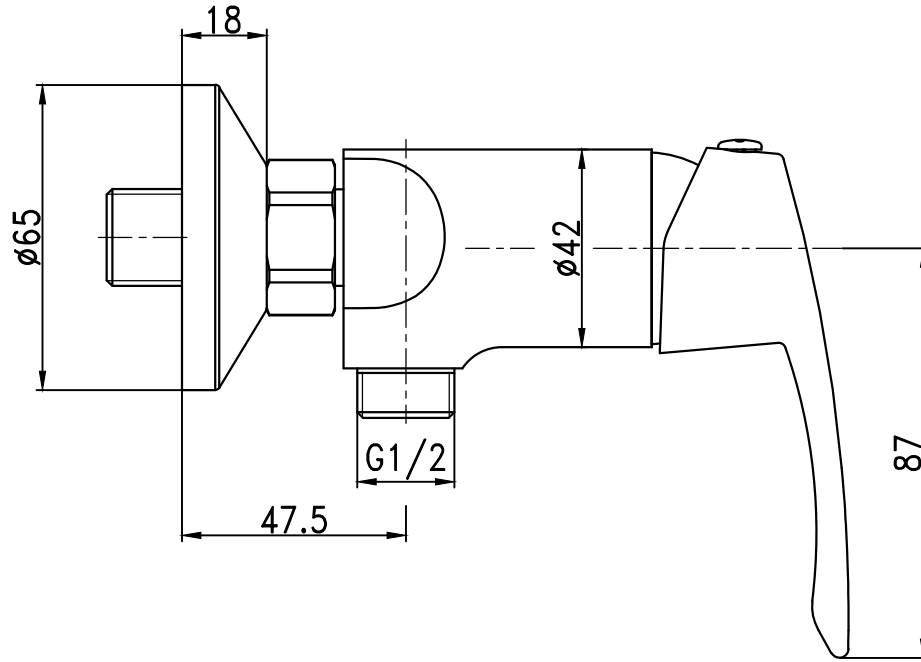

**L10 55 00**